

## T7316E Telephone User Card

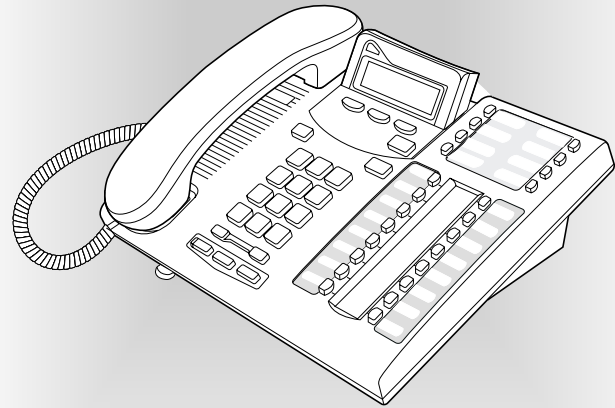

1-800-4 NORTEL  
www.nortelnetworks.com  
© 2004 Nortel Networks  
P0609623 01  
Printed in Canada

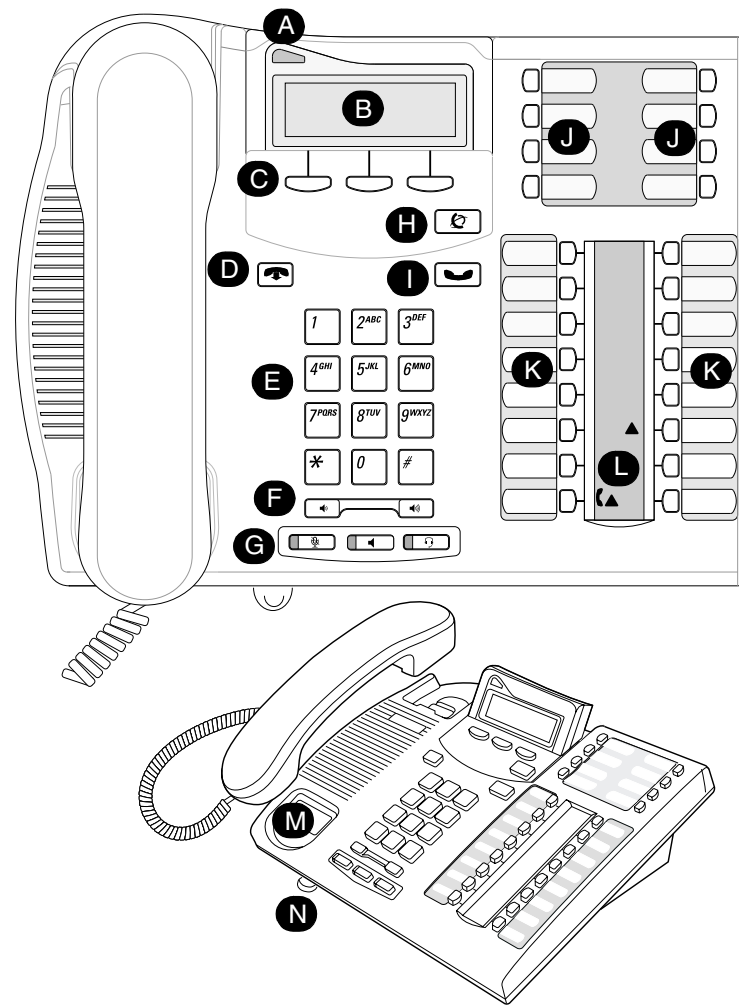

### Cord connections

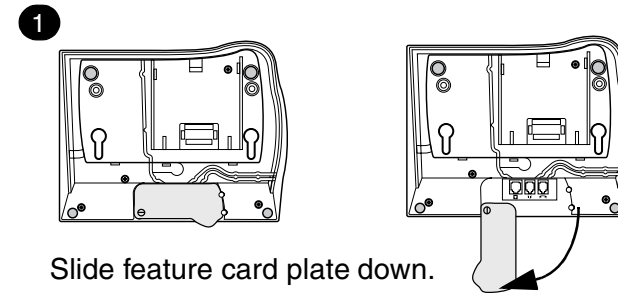

Slide feature card plate down.

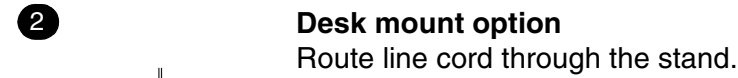

#### Desk mount option

Route line cord through the stand.

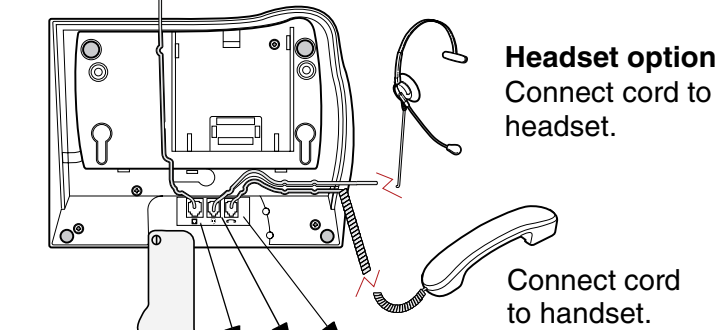

**Headset option**  
Connect cord to headset.

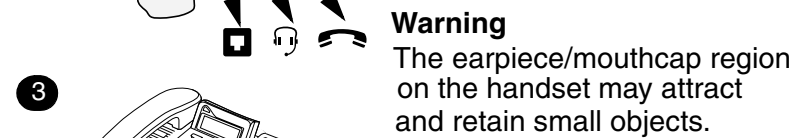

#### Warning

The earpiece/mouthcap region on the handset may attract and retain small objects.

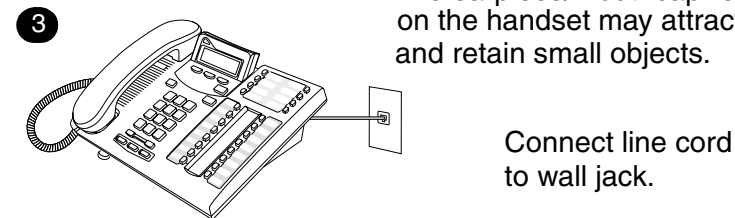

Connect line cord to wall jack.

### Wall mount with a telephone stand

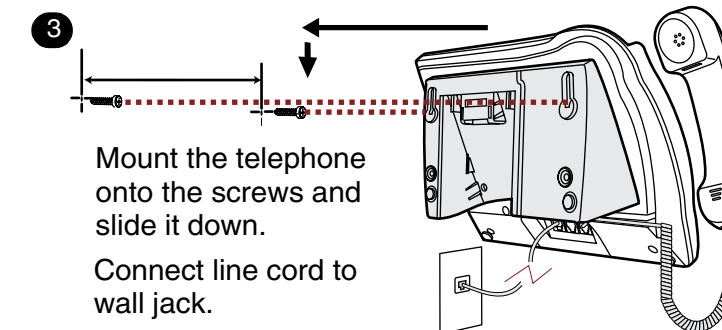
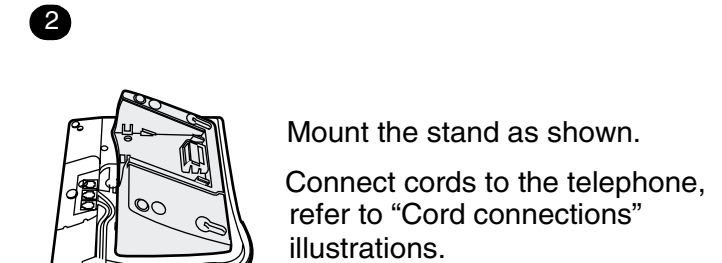
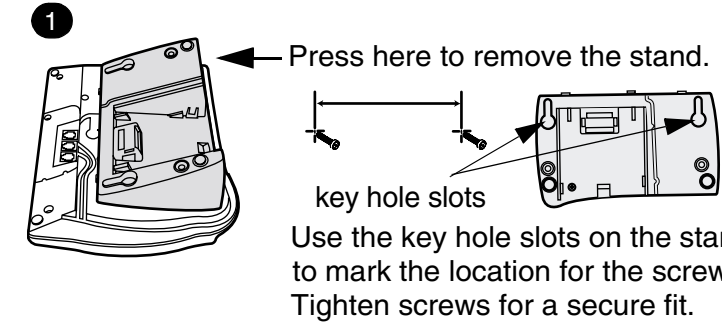

### Telephone setup

#### Display contrast level

Adjust the contrast of your display.

1. Press **[\*] [7]**.
2. Press **[UP]** or **[DOWN]** to view the levels.
3. Press **[OK]** to select a level.

#### Language choice

- [\*] [5] [0] [1]**  
Select Primary Language for the telephone display.
- [\*] [5] [0] [2]**  
Select Alternate Language for the telephone display.
- [\*] [5] [0] [3]**  
Select Alternate Language 2 for the telephone display.
- [\*] [5] [0] [4]**  
Select Alternate Language 3 for the telephone display.

#### Ring type

Select a different ring for your telephone.

1. Press **[\*] [6]**.
2. Press **[1]**, **[2]**, **[3]**, **[4]** or **[NEXT]** to hear the different ring types.
3. Press **[OK]** to store the ring type.

### Wall mount without a telephone stand

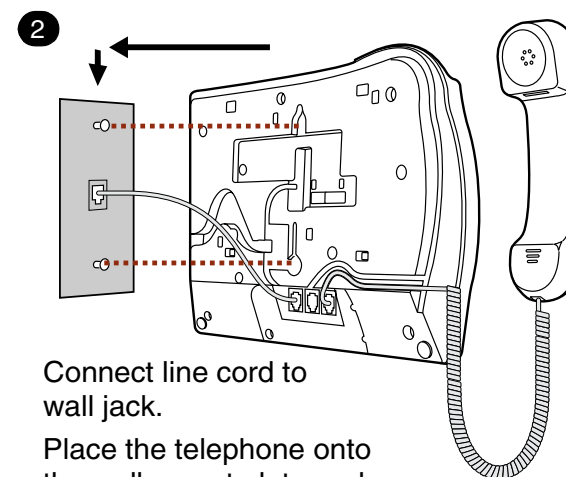
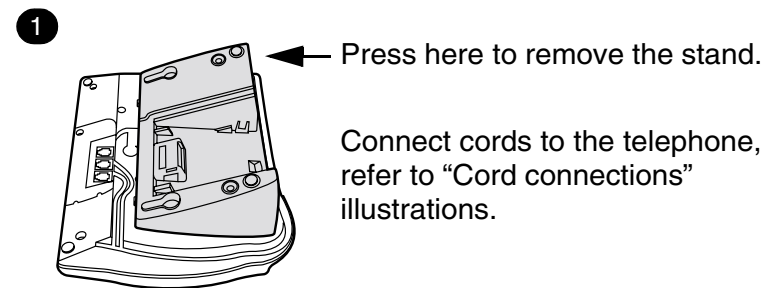

Connect line cord to wall jack.

Place the telephone onto the wall mount plate and slide it down.

### Your T7316E telephone

**A Telephone light**  
Flashes for incoming calls.  
Lights up when Message Waiting Indication (MWI) is supported by system software. Contact your system administrator for more information.

**B Adjustable tilt display**  
Shows the time and date, call and feature information.

**C Display buttons**  
The label for display buttons appear in capital letters on the bottom of the display. Display buttons change with each feature you use.

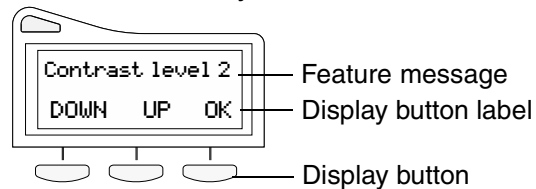

**D Release button**  
Ends an active call or feature.

**E Dial pad**

**F Volume control**  
Adjusts the handset, handsfree, headset and ringer volume.

### More on your T7316E telephone

**G Audio cluster buttons**

- Mute button**  
Turns the microphone off or on when you are on a call.
- Handsfree button**  
For more information on using the handsfree feature, refer to the "Handsfree calls" section in this card.
- Headset button**  
Turns the headset mode on.

**H Feature button**  
Starts or ends a feature.

**I Hold button**  
Places calls on hold.

**J Memory buttons**

**K Memory and line buttons**

**L Indicators**  
Appear next to active line and memory buttons.

**M Number card**  
Write your extension number on this card.

**N Feature card plate**  
Storage compartment for your feature card.

## Button inquiry

Check what is programmed on your buttons.

1. Press **[☎] [\*] [0]**.
2. Press the button(s) that you want to check.
3. Read the display. Button assignment examples are shown below.

<b>Line</b> XXX (LINENAME) SHOW OK	<b>Intercom</b> XXXX (SETNAME) NEXT VIEW
<b>Internal autodial</b> Autodial (XXXX)	<b>External autodial</b> (XXXXXXXXXX)
<b>Feature</b> (FEATURENAME) SHOW OK	

4. Press **[☎]** or **[☎]** when finished.

## Button labels

Use the three button label strips on the telephone to show what is programmed on the buttons.

Spare button label strips are provided with your telephone.

### How to label your buttons

1. Remove the plastic lens and button label strips from the telephone.
2. Write the name of each button on the button label strip.
3. Insert the button label strip back on the telephone.
4. Insert plastic lens, matching the tabs on the lens with the notches on the telephone.

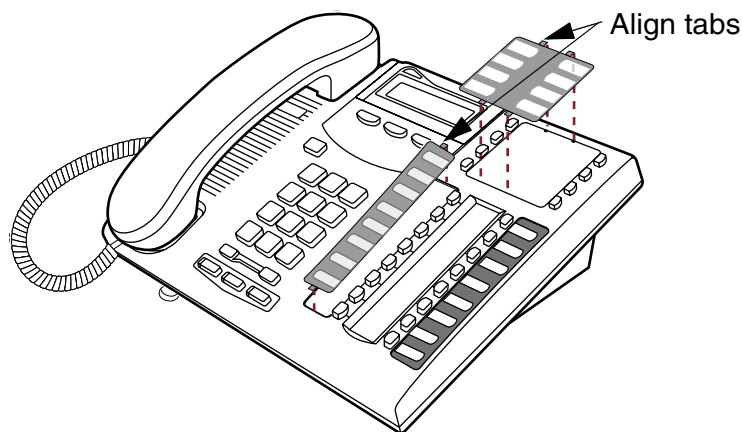

### Tip

Use the Desktop Assistant application to customize button label strips for your telephone.

Go to [www.nortelnetworks.com](http://www.nortelnetworks.com) and download the Desktop Assistant application to your personal computer.

## Memory buttons

Memory buttons are buttons not assigned as line, intercom or handsfree buttons.

Memory buttons store internal and external numbers or features to give you one touch dialing or feature activation.

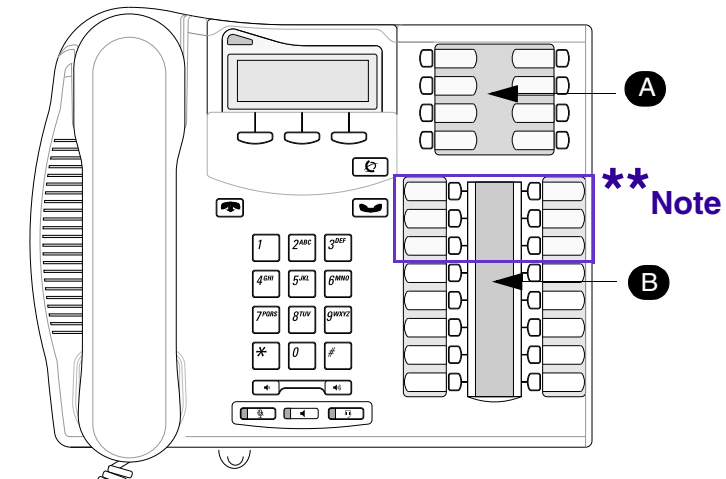

**A** Memory buttons without indicators for autodial numbers and features.

**B** Memory, line or intercom buttons with indicators. Depending on system software and feature activation, the type of indicators shown for memory, line or intercom buttons will vary.

Examples:



**\*\* Note** In older system software versions, these six buttons are assigned as memory buttons only. Indicators (▲) will appear for internal autodial numbers only.

## Programming memory buttons

You can program a memory button with a new number or feature.

### External autodial

1. Press **[☎] [\*] [1]**.
2. Press a memory button.
3. Dial the external number.
4. Press **[OK]** to store the number.
5. Label your new button.

### Internal autodial

1. Press **[☎] [\*] [2]**.
2. Press a memory button.
3. Dial the extension number.
4. Press **[OK]** to store the number.
5. Label your new button.

### Features

1. Press **[☎] [\*] [3]**.
2. Press a memory button.
3. Press **[☎]** and enter the feature code.
4. Press **[OK]** to store the feature code.
5. Label your new button.

### How to erase memory buttons

1. Press **[☎] [\*] [1]**.
2. Press a memory button.
3. Press **[OK]** to erase the button.

## Making and answering calls

### Making calls

There are many ways to make a call, depending on your telephone programming and the type of call.

#### External calls using line buttons

1. Lift the handset.
2. Press a line button. The line button indicator (▲ or ▲) turns on.
3. Dial the external telephone number.

#### External calls using intercom buttons

1. Lift the handset.
2. Press an intercom button. The intercom button indicator (▲ or ▲) turns on.
3. Enter a line pool access code.
4. When you hear an external dial tone, dial the external telephone number.

Contact your system administrator for a list of line pool codes.

#### Internal calls using intercom buttons

1. Lift the handset.
2. Press an intercom button. The intercom button indicator (▲ or ▲) turns on.
3. Dial the extension number.

Contact your system administrator for a list of extension numbers.

### Answering calls

When your telephone rings and the display light flashes or when an intercom or line button indicator (▲ or ▲) flashes:

- Lift the handset.  
OR  
Press the button with the flashing indicator (▲ or ▲) before you lift the handset.

### How to hold calls

- While on a call, press **[☎]**. The indicator (▲ or ▲) for the line on hold will flash.
- To retrieve a held call, press the line button with the flashing indicator (▲ or ▲).
- Calls are put on hold automatically when you switch from one line to another.

### How to mute calls

- While on a call, press **[☎]** to turn the microphone off. The **[☎]** light flashes when the microphone is off.
- The microphone remains off for your current call and all other calls until you press **[☎]** again to turn the microphone on.
- Use **[☎]** on handset, handsfree or headset calls.

## More on making and answering calls

### Handsfree calls

Your system administrator must enable the handsfree feature for your telephone in system programming.

- Press the handsfree button on your telephone to make or answer a call.
- To switch to handsfree when you are on a call, press the handsfree button and replace the handset. Lift the handset to switch back.

Depending on the system software, the handsfree feature will be assigned to one of these buttons on your telephone.

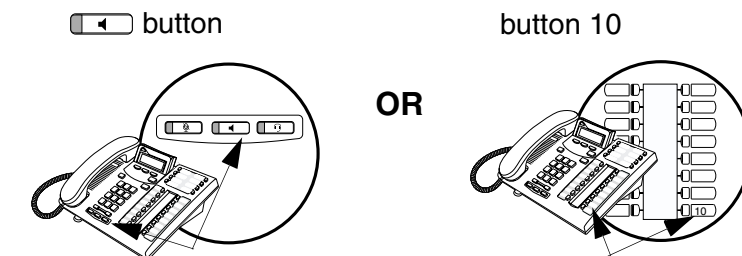

### How to determine the handsfree button assignment on your telephone

- Press **[☎]**.
- If you hear dial tone, **[☎]** is the assigned handsfree button on your telephone.
- If the display shows *Needs Handsfree*, your system administrator must enable the handsfree feature for your telephone in system programming.
- If you hear an error tone, the handsfree feature is assigned to button 10 on your telephone.

### Headset calls

- Press **[☎]** to activate the headset mode. When the **[☎]** light is on, press a line or intercom button to make a call.
- Press **[☎]** to answer a call when the telephone rings or when an intercom or line button indicator (▲ or ▲) flashes.
- To switch to your headset when you are on a call, press **[☎]** and replace the handset. Lift the handset to switch back.

### Warning

Nortel Networks does not support the connection of a headset to the T7316E telephone, unless handsfree is enabled within the system programming. If handsfree is not enabled, certain call handling features may not work as intended.

## Other documents

Read the *Telephone Feature Card* for more information on using telephone features.